

Robot Stadium Light Series

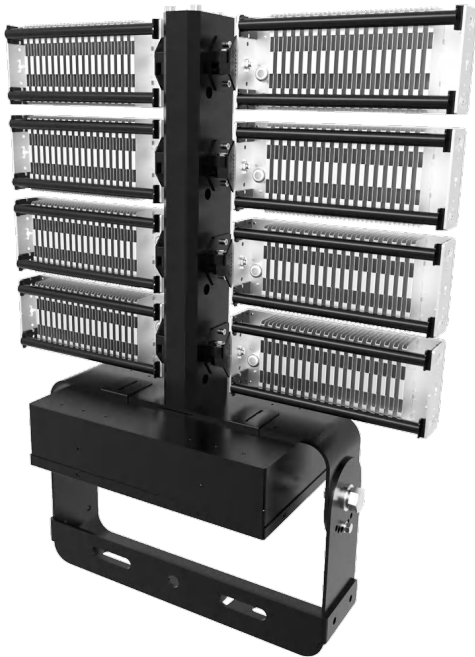

Module rotation angle:

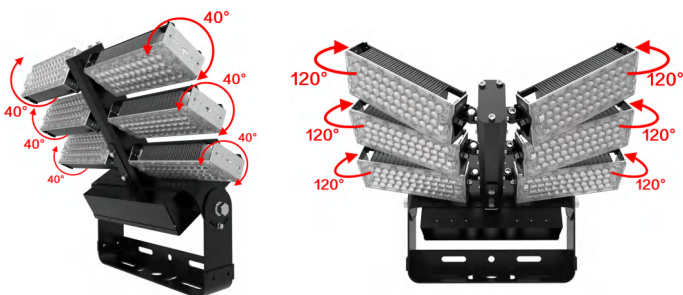

Basic Parameters

Efficacy: 155lm/W±3%

LED Chip: LUMILEDS

SDCM: <5

Beam Angle: 20°/40°/60°/90°/140°x100° PC lens

IP Rated: IP65

Installation: Bracket

Certifications: CE, RoHS

Warranty: 7 Years

Application

Large stadium, all kinds of large stadium, ships, squares, docks, airports, commercial sites, overpass, outdoor advertising, landmarks and other large panoramic lighting.

Photometry

20° PC lens

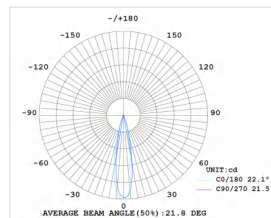

40° PC lens

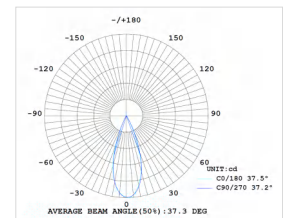

60° PC lens

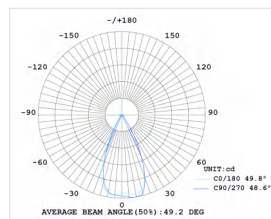

90° PC lens

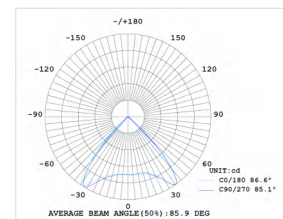

140°x100° PC lens

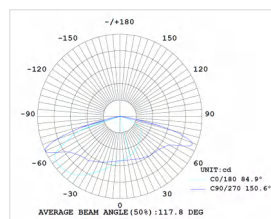

Robot Stadium Light Series

Specifications

Model NO.:	HR-T-HM-B720W-LV(XXK)	HR-T-HM-B960W-LV(XXK)	HR-T-HM-B1200W-LV(XXK)	HR-T-HM-B1440W-LV(XXK)
Input Power	720W	960W	1200W	1440W
Lumen Fixture (5000K)	111,600 lm	148,800 lm	186,000 lm	223,200 lm
Luminous Efficiency	155lm/w			
Power Factor	0.98			
Input Voltage	100-277 VAC			
CCT	3000K/4000K/5000K/5700K/6500K			
CRI	70Ra / 80Ra / 90Ra/97Ra			
Housing Color	Black & Silver			
Housing Material	Die-cast Aluminum, PC lens			
Operating temperature	-30°C to +45°C			
Operating humidity	10% to 90% RH			
Lifespan	50,000 hours			
Warranty	7 Years			

Packaging

Brief Code	PCS/CTN	Net Weight	Volumetric Weight	CBM
HR-T-HM-B720W-LV	1PCS	26.0 kg	60.0 kg	L862*W467*H657 mm \approx 0.297 m ³
HR-T-HM-B960W-LV	1PCS	28.0 kg	70.0 kg	L862*W467*H789 mm \approx 0.349 m ³
HR-T-HM-B1200W-LV	1PCS	34.0 kg	82.0 kg	L862*W467*H921 mm \approx 0.410 m ³
HR-T-HM-B1440W-LV	1PCS	38.0 kg	94.0 kg	L862*W467*H1053 mm \approx 0.471 m ³

Robot Stadium Light Series

Product model coding principles

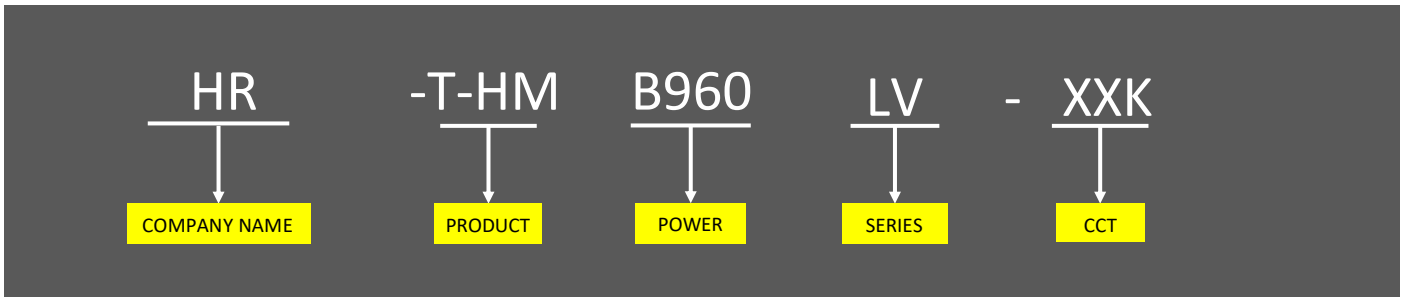

Dimension (unit: mm)

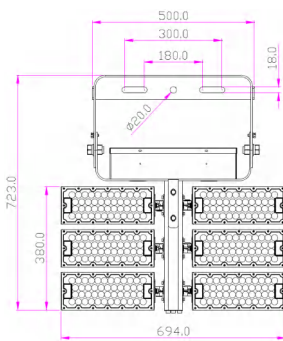

HR-T-HM-B720W-LV(XXK)

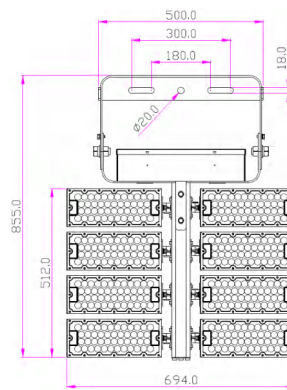
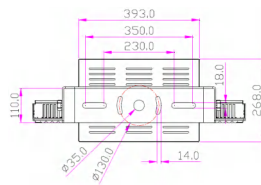

HR-T-HM-B960W-LV(XXK)

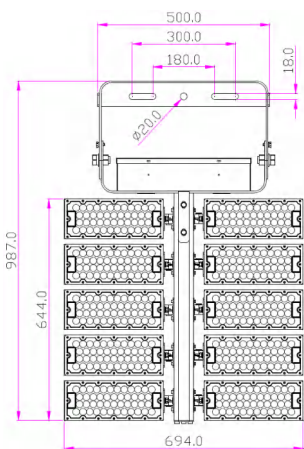
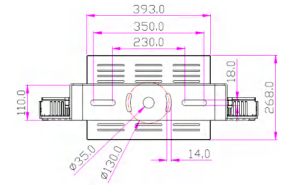

HR-T-HM-B1200W-LV(XXK)

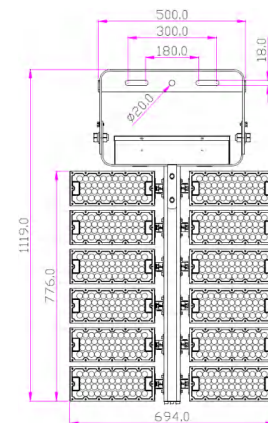
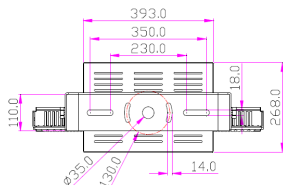

HR-T-HM-B1440W-LV(XXK)

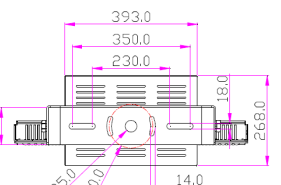

Robot Stadium Light Series

Packaging Image

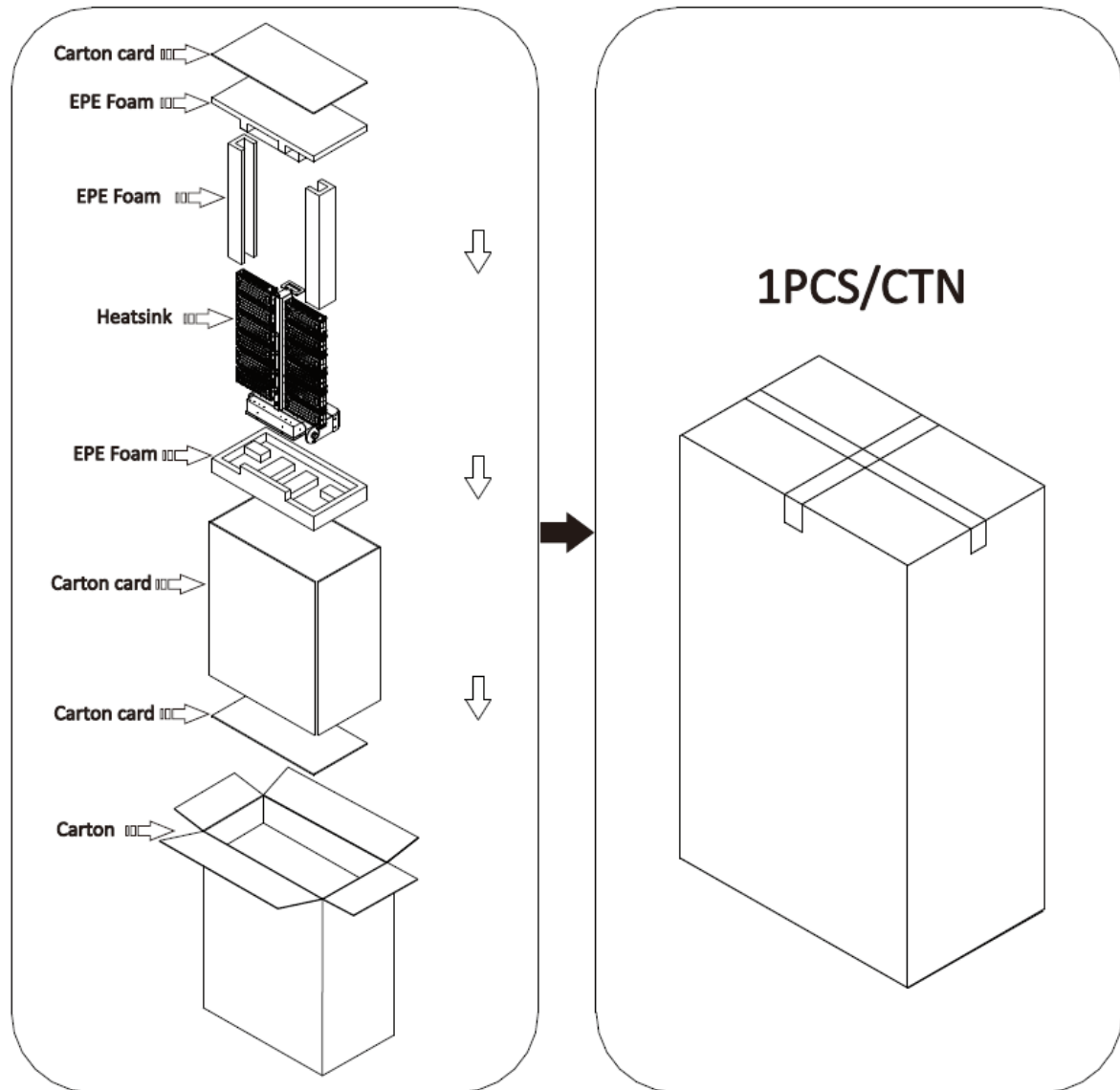

Engineering Case

